

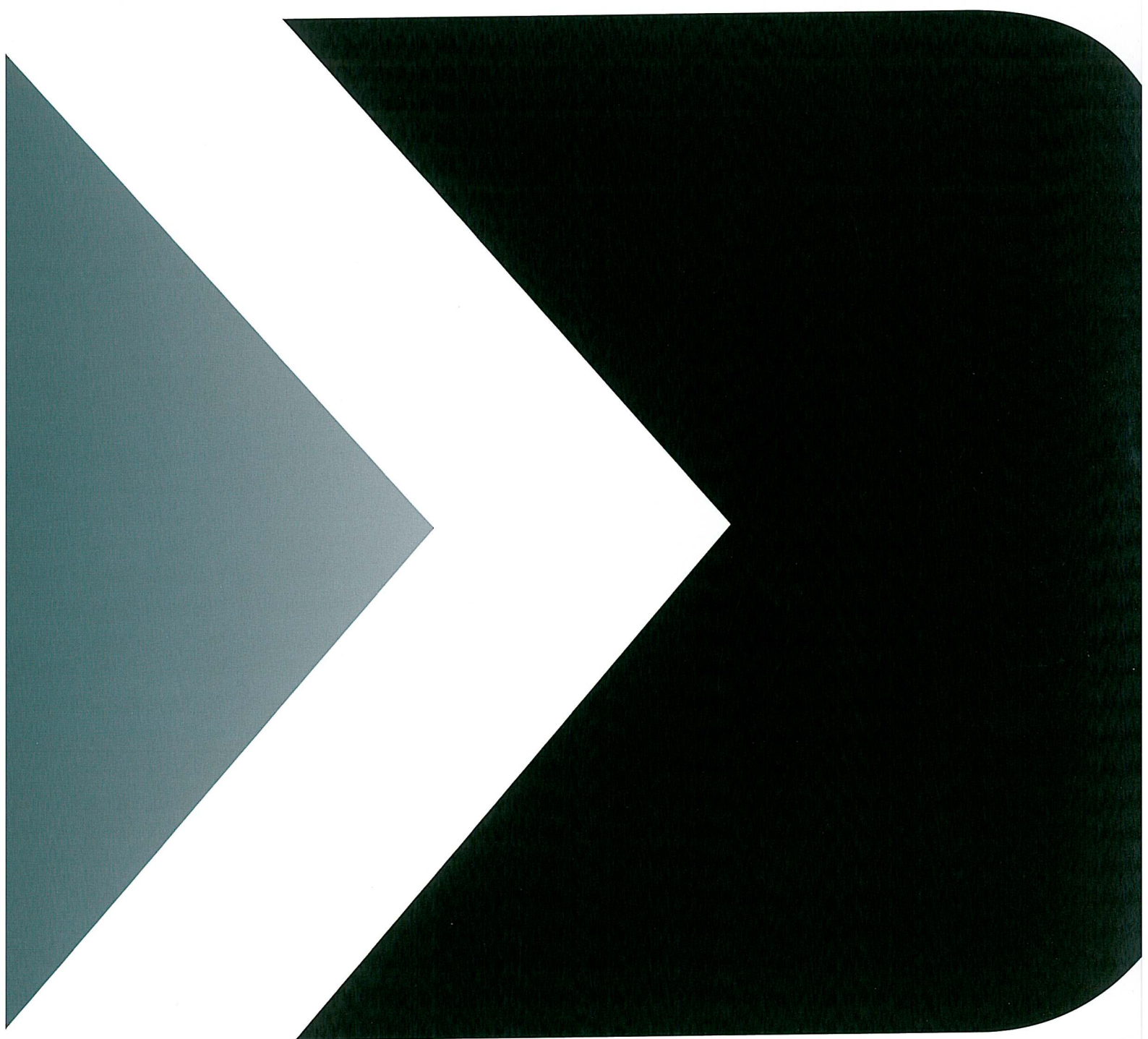

KONICA MINOLTA

REGIUS Σ



The essentials of imaging

Konica Minolta has been a CR technology leader since 1996 - consistently designing, developing, and delivering innovative solutions. The REGIUS Σ represents the sum of this experience. REGIUS Σ delivers a compact and affordable imaging solution that maintains the superior image quality and reliability expected from our REGIUS family of products. Combined with the redesigned ImagePilot software, the REGIUS Σ provides simple operation and smooth workflow to a wide range of medical practitioners.

REGIUS Σ

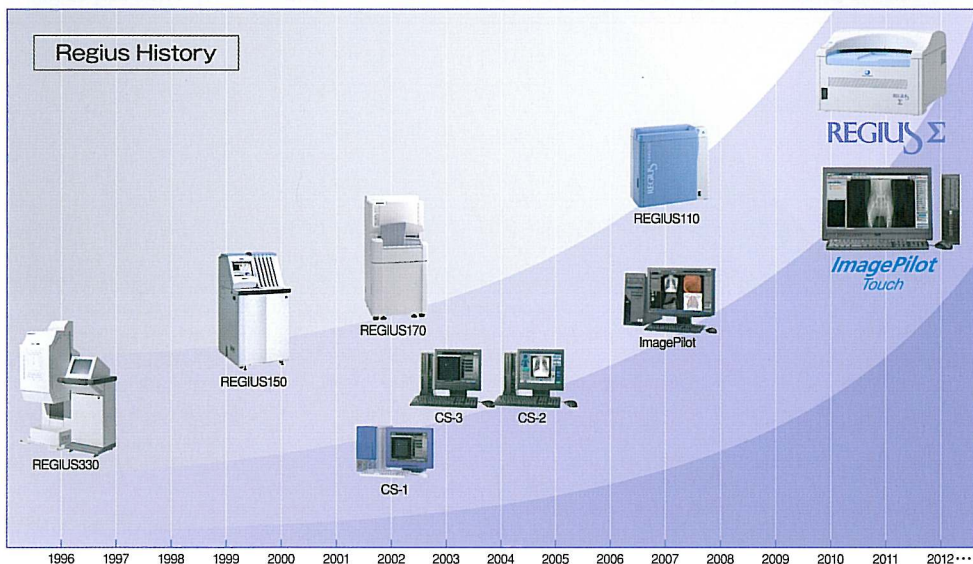

From patient registration to long term archive

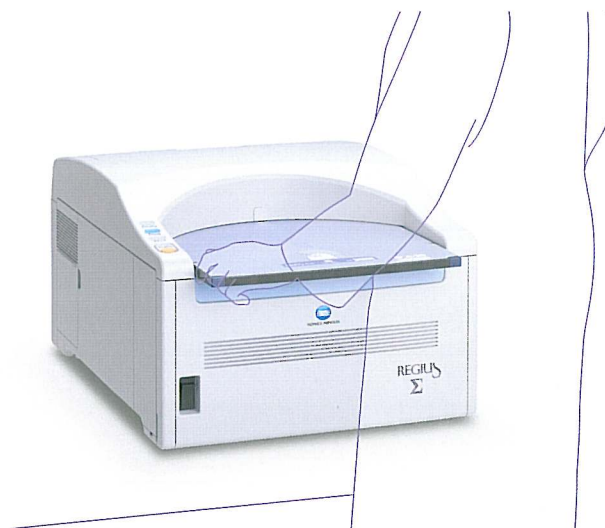
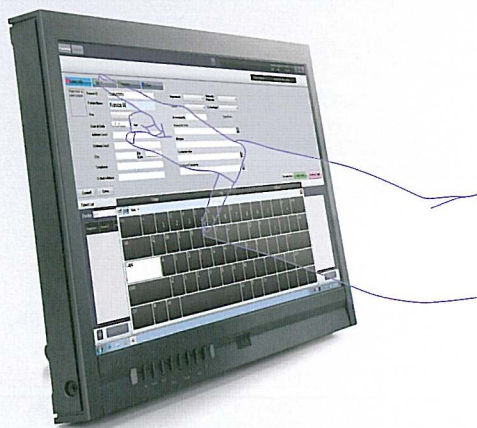

I. Register

Manual or automated patient registration from anywhere in the office. Select the patient from the worklist or input patient information. No need to specify body part or exam type.

II. Digitize

Just insert an exposed cassette into the REGIUS Σ CR reader. The ImagePilot then automatically processes the image for optimised diagnostic viewing.

■ Patient data management

The ImagePilot server can manage more than 200,000 patients. With any registered patient, users can acquire new images or review prior exams.

■ Seamless Link with EMR and RIS

You can acquire patient information from an EMR or RIS which supports MWM.

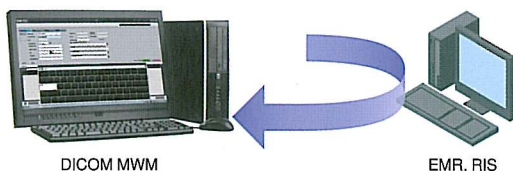

■ Useful Registration

Use an existing PC* (i.e. at the reception area) for patient registration, if desired.

*Please confirm the specification for the client PC of ImagePilot

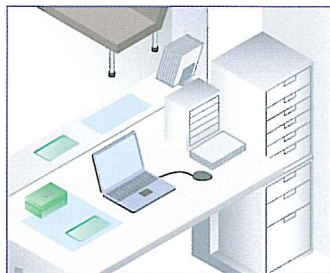

■ Quick Preview

Fully automated image processing produces consistent optimised images that display within 45 seconds.



■ Print composition

ImagePilot supports a print composer mode. Use this mode from any client station to print multiple images on one sheet of film or paper.



■ Easy recovery

If a plate jam occurs, it can be removed easily by opening the top cover or the backside cover.

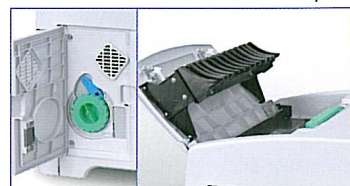

Konica Minolta provides complete workflow.

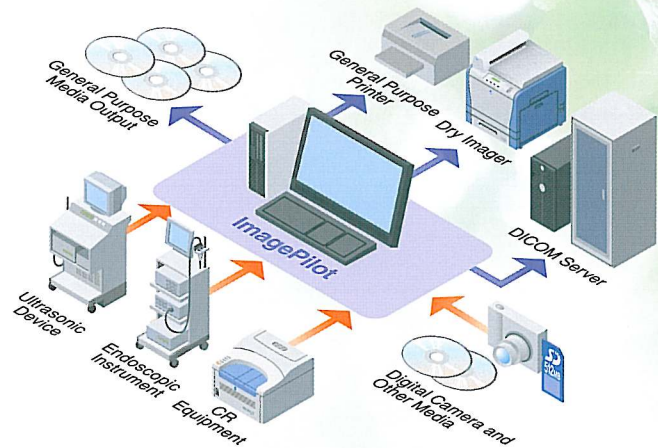

III. View

Images can be viewed at up to 20 ImagePilot client workstations throughout the office. Each client supports all the same ImagePilot functions - the same GUI at every workstation.

Multifunctional Viewing

ImagePilot supports over 100 features and functions.

- **Annotation**
Line/Arrow/Rectangle/Text/Shutter/Marker, etc.
- **Scaling**
Vertebral Heart Scale/Distance/Angle/Cobb Angle, etc.
- **Image Tools**
Window Level/Zoom/Pan/Magnifier/REGIUS Processing, etc.
- **Report**
- **Other Modality Image**

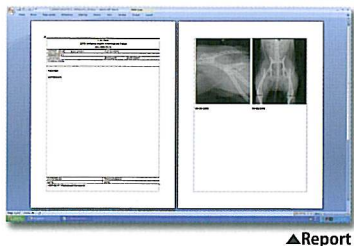

Web Viewing

At home or at your secondary practice location, you can view the images on your ImagePilot server via VPN.

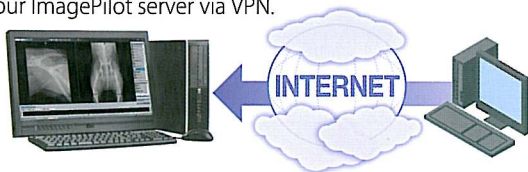

IV. Archive

With storage capacities up to 2TB, ImagePilot can archive up to 300,000 images on its expandable servers. And this can be expanded even further with add-on storage.

*For available configurations, please contact your salesperson.

DICOM Image Communication

ImagePilot supports DICOM Store for sending patient images to a remote PACS or for receiving images from other PACS systems or modalities. ImagePilot also supports DICOM query/retrieve for greater utility.



NAS/DVD Backup

To secure the data stored on the ImagePilot server, you can create a backup on CD/DVD or NAS.

PDI Output

To easily share patient data with other clinics, hospitals or clients, ImagePilot can create a PDI CD/DVD which includes a DICOM viewer.

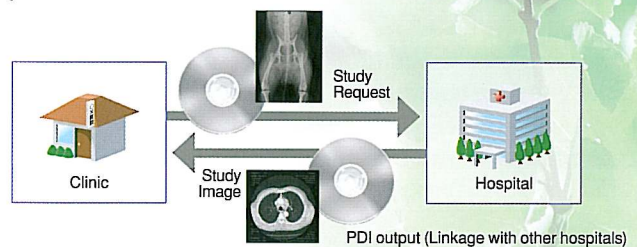

COMPACT

REGIUS Σ

■ Konica Minolta's Ultra-Compact CR

The REGIUS Σ is Konica Minolta's smallest and lightest CR. The desktop CR has a footprint of only 1.31m² and weighs a mere 28kg.

0.11m³
& 28kg

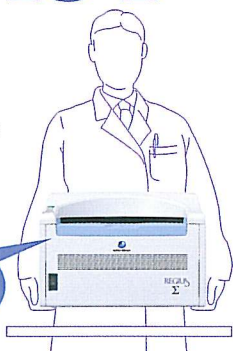

■ Environmentally Friendly

The REGIUS Σ was designed with the environment in mind. Energy consumption has been reduced to 100VA - about the same as a household light bulb, That's one tenth the power of the smallest film processor.



HIGH QUALITY

■ High Resolution

The REGIUS Σ supports pixel sizes of 87.5 μ m and 175 μ m for all cassette sizes, achieving a maximum resolution of 4020x4892 pixels (35x43 cm at 87.5 μ m).

87.5 μ m/
175 μ m



■ Integral Processing

Integral Processing - the result of Konica Minolta's vast imaging experience - is a robust algorithm that produces the optimum diagnostic image automatically. This patented technique greatly simplifies X-ray image acquisition while delivering incredibly consistent image quality and virtually eliminating retakes.

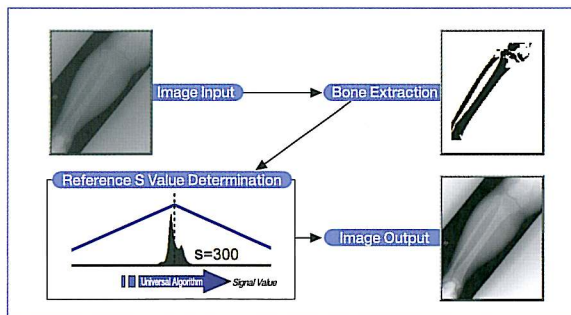

SMART CONSOLE

ImagePilot

■ All-in-One!

The ImagePilot software combines CR image acquisition and PACS functionality. It is a complete workflow solution for clinics, imaging centers, and small hospitals. From one GUI, users can acquire, review, distribute and archive patient images.



■ Easy Control

ImagePilot supports a multi-touch display for the easiest operation. More than 100 functions are literally at the tips of your fingers.



REGIUS SIGMA Specifications

■ Cassette size

14"x17", 14"x14", 11"x14",
15x30cm, 24x30cm, 18x24cm

■ Sampling Pitch

2 Types: 87.5µm / 175µm

■ Maximum Resolution

4,020x4,892 (14"x17", 87.5µm)

■ Digital Gradation Level

4096 levels (12 bit)

■ Processing Capability

Up to 25 plates / hour (14"x17", 175µm)

■ Slots

Insertion / ejection slot x 1

■ Outer Dimensions/Weight

W510 x D610 x H355mm / Approximately 28kg

■ Power Supply Conditions

100VA max during operation: 20VA when not in use

■ Operating Conditions

Temperature : 10-30°C

Humidity : 15-80% RH (No Condensation)

■ Readable Cassette

REGIUS CASSETTE RC-300

14"x17", 14"x14", 11"x14", 24x30cm, 18x24cm, 15x30cm

■ Readable Plate

REGIUS PLATE FP-1S

14"x17", 14"x14", 11"x14", 24x30cm, 18x24cm, 15x30cm

REGIUS SIGMA Outer Dimensions

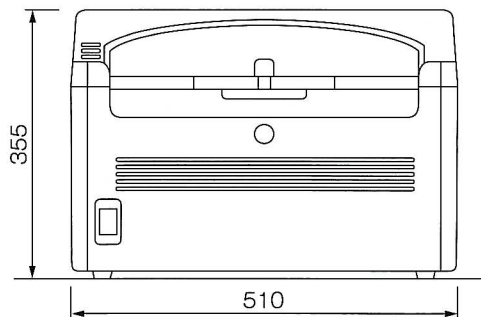
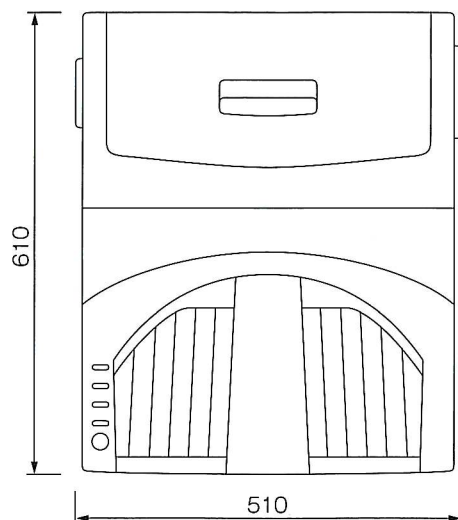

Unit: mm 1/10 scaled

Brand Name : REGIUS Σ
Type : DIRECT DIGITIZER
Model : REGIUS SIGMA

★Specifications are subject to change without prior notice.



KONICA MINOLTA

KONICA MINOLTA MEDICAL & GRAPHIC IMAGING EUROPE B.V.

Frankfurtstraat 40, 1175RH Lijnden, the Netherlands

Distributed by :